

HP-005 ELECTRONIC CONTROL BOX 电控箱 | **使用说明书**
INSTRUCTION MANUAL BOOK

上海富山精密机械科技有限公司
Hikari(shanghai)precise Machinery Science&technology Co.,Ltd

中国上海市金山区朱泾工业园区中达路800号
NO.800.zhongda Road,jinshan Zone,shanghai,china

电话: (00) 86-21-67311111
TEL: (00) 86-21-67311111
传真: (00) 86-21-67311311
Fax: (00) 86-21-67311311
E-mail:hikari@chinahikari.com
http:www.chinahikari.com



此说明书仅作参考。如有更改恕不另作通知。
This manual is only for reference.
IF there is any modification , we apologize for the changing hence caused.



通过 ISO9001:2008
质量管理体系认证

前 言

感谢您选用本公司的产品，该手册提供了此系统所需要的操作指导说明。

为了您更好地使用该产品，在使用之前请仔细阅读本手册。

- 由于产品的改进，本手册内容可能随时变更，恕不另行通知。
- 您在使用中若有任何疑问或对我们的产品和服务有任何意见，请随时与我们售后服务部联系。

PREFACE

Thank you for selecting our product. The introduction provides necessary knowledge and notes for using.

Please read safety introduction carefully and understand them before using.

- The content of the introduction will be amended with the improvement of our product, the notice is not announced.
- If you have any doubts or comments about our product and service, please contact after-sale service.

目 录

0. 主要技术数据	3
1、 安全注意事项	3
1.1 使用范围	3
1.2 工作环境	3
1.3 安装	3
1.4 保养维修的规定	3
1.5 危险提示	4
1.6 其它安全规定	4
2. 安装与调整	4
2.1 控制箱的安装	4
2.2 停针位的调整	4
2.3 脚踏板后踏力量的调整	5
3. 接线与接地	5
3.1 电源线的接法	5
3.2 控制器接线端子图:	6
3.2.1 通用型接线端子图（平缝、绷缝和包缝等）	5
3.2.2 专用型接线端子图（包缝（含第三光眼功能））	6
3.2.3 专用型接线端子图（细嘴包缝）	7
4. 主控制箱面板操作说明书	8
4.1 主控制箱面板的布局如下示意图	8
4.2 待机状态	8
4.3 缝纫模式及各段针数设置	9
4.4 前固缝方式及针数设置	10
4.5 后固缝方式及针数设置	10
4.6 工艺参数设置	11
4.7 常用参数说明表	13
5. 故障码/故障原因/故障排除方法表	15
6. 七段数码管显示值与实际数值对照表	16

0. 主要技术数据

供电电压范围：AC220V±15%

供电电源频率：50Hz/60Hz

1、 安全注意事项

1.1 使用范围

本伺服控制器是为工业缝纫机开发设计的，如果在其它方面使用，请注意使用者的安全。

1.2 工作环境

1.2.1 电源电压请遵照控制箱铭牌所标示电压±15%范围内。

1.2.2 请远离高频电磁波发射器等，以免所产生的电磁波干扰本控制器而发生错误动作。

1.2.3 温湿度：

a.请在室温 5°C 以上、 45°C 以下的场所操作。

b.禁止在日光直接照射的场所或室外运作。

c.请不要过于接近暖气 (电热器) 旁运作。

d.请保持 30 % ~ 95 % 相对湿度 (无凝露)。

1.2.4 请不要在可燃气体或爆炸物附近操作。

1.3 安装

1.3.1 控制器请遵照说明书进行正确安装。

1.3.2 安装前请先关闭电源并拔掉电源线插头，然后进行安装。

1.3.3 装钉电源线时请避免靠近会转动部件，最少要离开 3 公分以上。

1.3.4 为防止噪声干扰或触电事故，请将缝纫机、控制箱接地。



1.3.5 打开电源之前，确定此供应电压必须符合标示在控制箱铭牌上的指定电压±15%范围内。

1.4 保养维修的规定

1.4.1 在操作保养或维修动作前，请先关闭电源。

1.4.2 翻抬机头时，与更换机针或梭子或穿线时，请确认电源已关闭。

1.4.3 控制箱里面有危险高压电，所以关闭电源后要等 5 分钟以上方可打开控制箱盖。

1.4.4 修理及保养的作业，要请经过训练的技术人员执行。

1.4.5 不能在电机及控制箱运转的状态下进行保养或维修。

1.4.6 所有维修用的零件，须由本公司提供或认可，方可使用。

1.5 危险提示



这个标示符号表示机器在安装时，安全上需要特别加以注意的事项，忽视此标记而进行错误操作可能会导致人员或是机器损伤。

1.6 其它安全规定

- 1.6.1、在第一次接通电源后，请先以低速操作缝纫机并检查转动方向是否正确。
- 1.6.2、缝纫机运转时，请不要去触摸上轮、机针等会动作的部位。
- 1.6.3、所有可动作的部份，必须以所提供的防护装置加以隔离，防止身体接触并请勿在装置内塞入其它物品。
- 1.6.4、请不要在拆下电机护罩及其它安全装置的情形下操作。
- 1.6.5、不要使电机或控制箱掉在地上。
- 1.6.6、不要让茶水等液态物体流入控制箱或电机内部。

2. 安装与调整

2.1 控制箱的安装

- 1).将控制箱及脚踏控速器安装于台板下方 2). 将踏板与控速器安装连结 3).安装后示意图

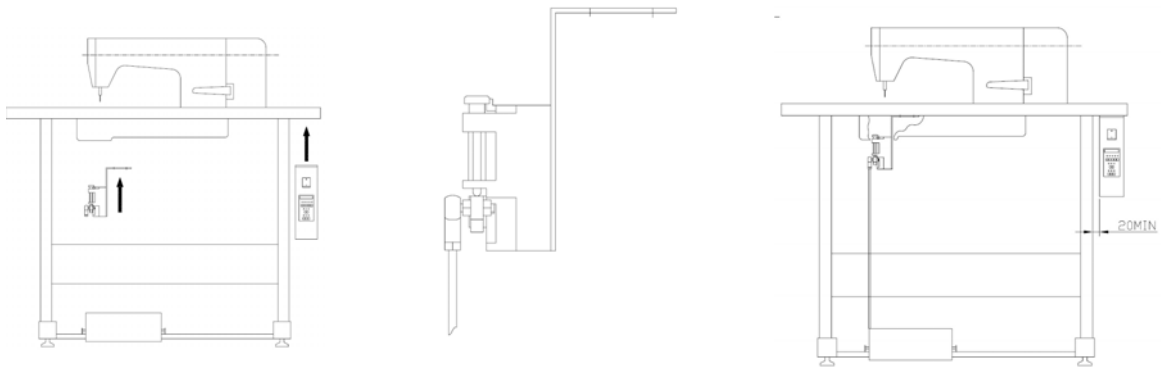

2.2 停针位的调整

- 2.2.1、松开手轮上的磁钢固定螺丝，调整位置后重新固定；
- 2.2.2、如果实际上停针位超过了预期上针位，将信号磁钢固定盘顺手轮旋转方向调节，反之，逆手轮旋转方向调节。

2.3 脚踏板后踏力量的调整

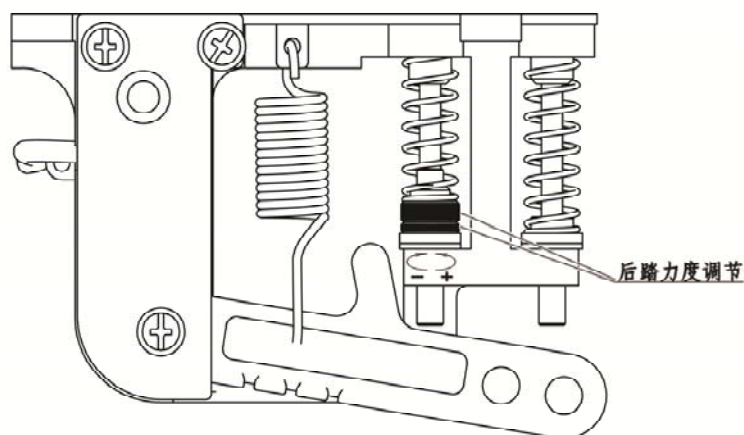

调整需求	调整结果
踏板后踏力量的调整	当螺栓愈向上时，则后踏力量愈重。当螺栓愈向下时，则后踏力量愈轻。

3. 接线与接地

3.1 电源线的接法

本控制器适用于AC220V单相电源，电压输入范围为铭牌标示电压 $\pm 15\%$ 。



注意：

黄/绿色电源线为接地线，为了人员安全及设备可靠工作，一定要做好系统的接地工程。

3.2 控制器接线端子图：

3.2.1 通用型接线端子图（平缝、绷缝和包缝等）

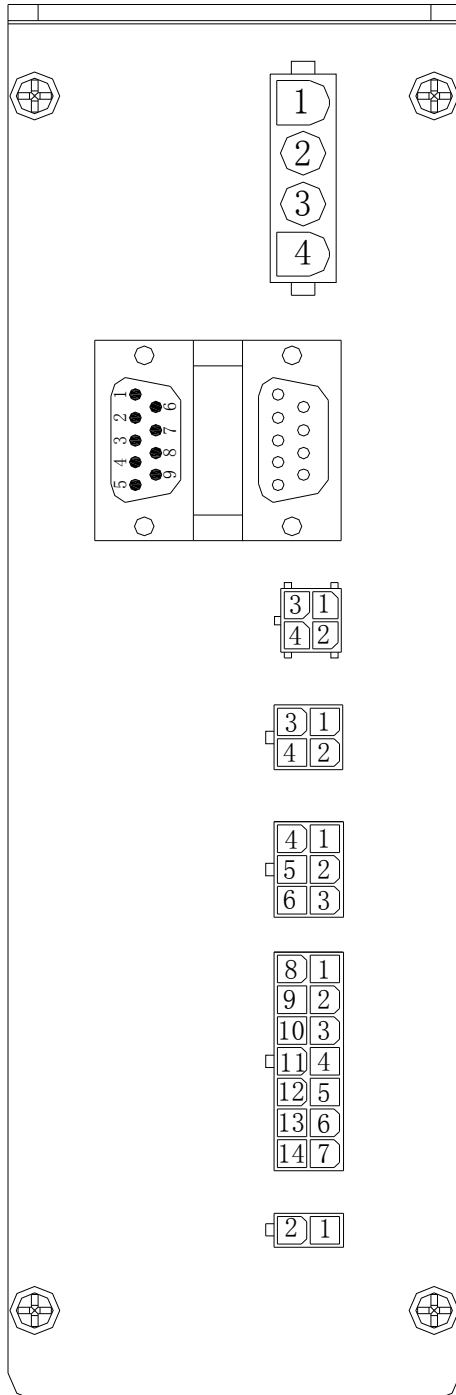

- 1、大地
 - 2、U相输出
 - 3、V相输出
 - 4、W相输出
-
- 1、+5V
 - 2、速度信号
 - 3、立式脚踏剪线控制
 - 4、立式脚踏识别
 - 5、GND
 - 6、GND
 - 7、GND
 - 8、立式脚踏抬压脚控制
 - 9、+5V
-
- 1、TXD
 - 2、+12V
 - 3、RXD
 - 4、GND
-
- 2、安全开关
 - 4、+5v
-
- 1、针位输出
 - 2、GND
 - 3、GND
 - 4、布边传感器信号
 - 5、GND
 - 6、布边传感器电源
-
- 1、+30v
 - 2、+30v
 - 3、大地
 - 4、+30v
 - 5、GND
 - 6、+30V PWM
 - 7、GND
 - 8、剪线输出
 - 9、挑线输出
 - 10、+30V
 - 11、NC
 - 12、手动到缝开关
 - 13、到缝输出
 - 14、+5V照明
-
- 1、+30V PWM
 - 2、抬压脚输出

3.2.2 专用型接线端子图（包缝（含第三光眼功能））

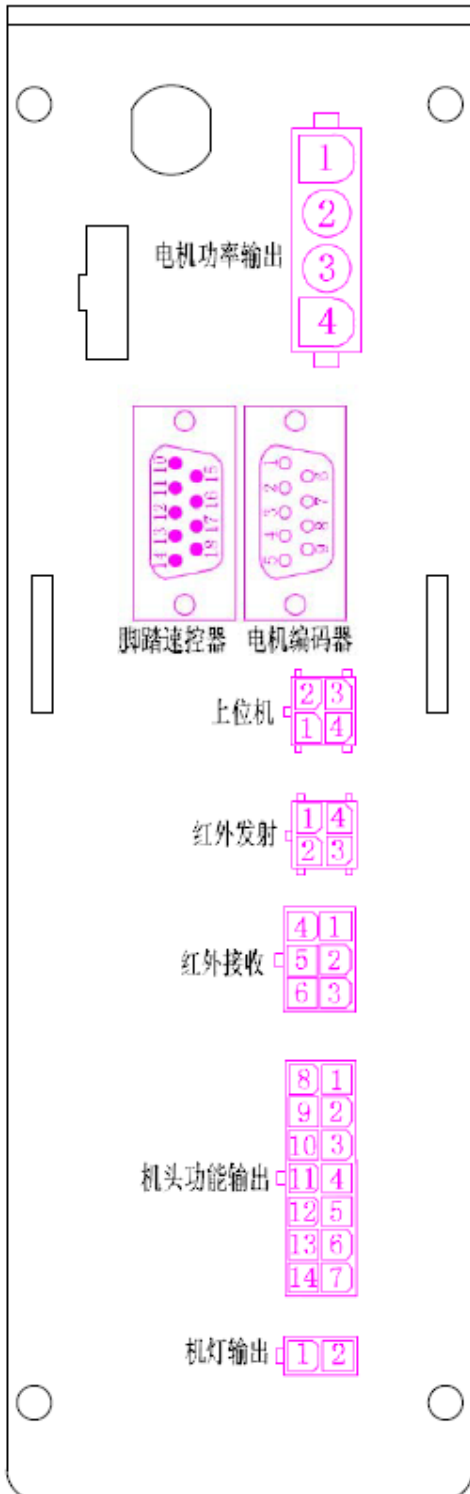

1	接地线			电机功率输出			
2	电机U相						
3	电机V相						
4	电机W相						
脚踏控速器				电机编码器			
10	+5V	15	GND	1	+5V	6	UH
11	定速信号	16	GND	2	上针位	7	VH
12	立式脚踏剪线控制	17	立式脚踏抬压脚控制	3	下针位	8	WH
13	立式脚踏识别	18	+5V	4	码盘B	9	GND
14	GND			5	码盘A		
2	RXD	3	TXD	上位机			
1	GND	4	+12V				
1	红外发射前	4	+5V	红外发射			
2	红外发射中	3	红外发射后				
4	红外接收前	1	+5V	红外接收			
5	红外接收中	2	+5V				
6	红外接收后	3	+5V				
8	剪线电磁铁	1	+30V	机头输出功能			
9	压脚电磁铁	2	+30V				
10	吸风电磁铁	3	预留				
11	拉轮电磁铁	4	预留				
12	压脚安全开关	5	GND				
13	手动开关	6	GND				
14	缝台安全开关	7	+5V				
1	+12V	2	照明输出	机灯输出			

3.2.3 专用型接线端子图（细嘴）

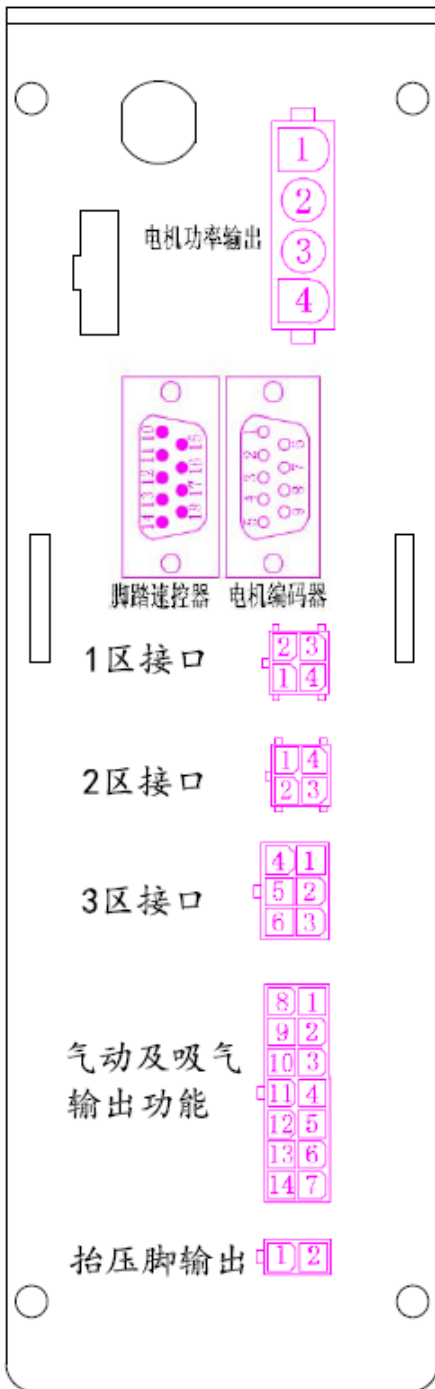

1	接地线			电机功率输出			
2	电机U相						
3	电机V相						
4	电机W相						
脚踏控速器			电机编码器				
10	+5V	15	GND	1	+5V	6	UH
11	定速信号	16	GND	2	上针位	7	VH
12	立式脚踏剪线控制	17	立式脚踏抬压脚控制	3	下针位	8	WH
13	立式脚踏识别	18	+5V	4	码盘B	9	GND
14	GND			5	码盘A		
2	无	3	无	1区接口			
1	无	4	无				
1	无	4	无	2区接口			
2	无	3	无				
4	无	1	无	3区接口			
5	无	2	无				
6	无	3	无				
8	无	1	无	气动及吸气输出功能			
9	膝控开关	2	+30V				
10	无	3	无				
11	无	4	无				
12	气动支撑架输出	5	GND				
13	吸气输出	6	+30V	抬压脚输出			
14	无	7	无				
1	+30V	2	抬压脚输出				



各部的连接插头于插入控制箱的插座时，要注意其形状和方向性，并确实插好。

4. 主控制箱操作说明

4.1 主控制箱面板的布局如下示意图

主控制箱（简称下位机）面板的布局如下示意图，共包含 T1~T6 六个数码管、十一个 LED 以及十个按键。面板有待机、缝纫模式设置、前固缝方式设置、后固缝方式设置、工艺参数设置共五种状态。

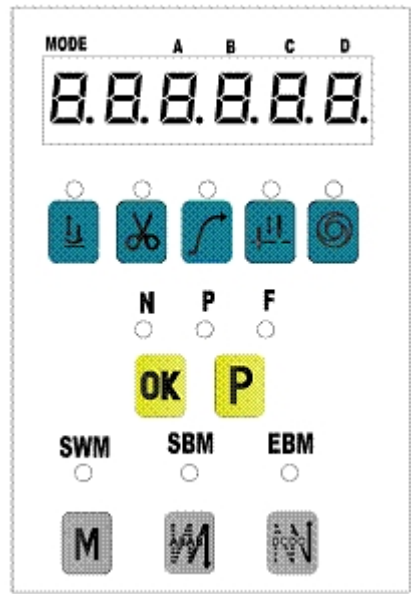



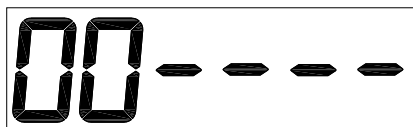

4.2 待机状态

1. 上电后,面板显示待机状态, N、P、F、SWM、SBM、EBM 全熄;各功能键上方的 LED 灯按当前参数值显示;

数码管 T1 T2 显示当前缝纫模式代码(00: 自由缝; 01: 定长缝; 02: 四段缝; 03: 七段缝; 04: 八段缝; 05: W 缝), 其余各数码管显示“-”。以当前缝纫模式是自由缝为例, 显示如下:



2. 选择      键, 对应的抬压脚、剪线、慢启动、停针位、自动触发等功能将被设置或取消, 同时对应的 LED 点亮或熄灭;

4.3 缝纫模式及各段针数设置



待机状态下按  键，进入缝纫模式设置状态：SWM 亮，其余 LED 全熄；





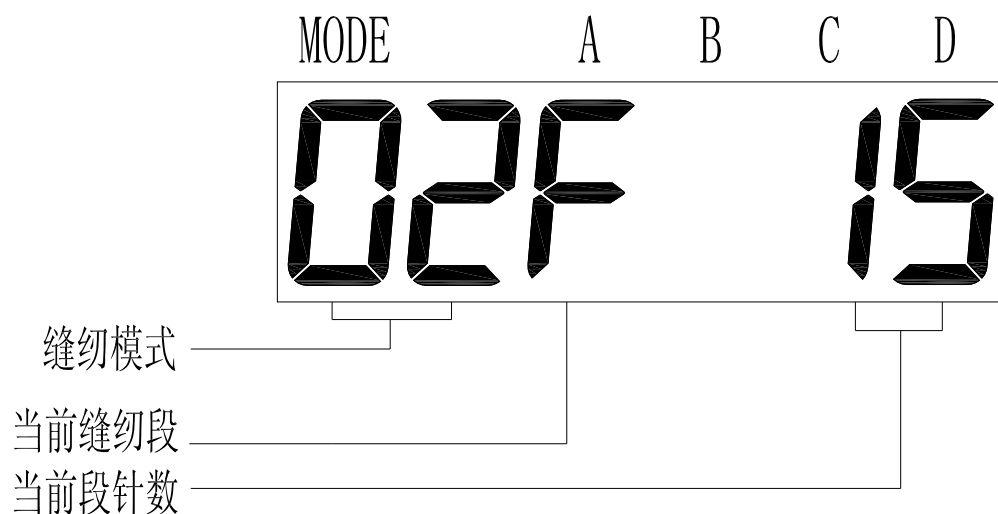

数码管 T1 T2 显示当前缝纫模式代码（00：自由缝；01：定长缝；02、四段缝；03：七段缝；04：八段缝；05：W 缝），若为定长缝或多段缝，数码管 T3 显示当前段代号“E、F、G、H”，数码管 T5、T6 显示当前段针数；

以四段缝为例，显示如下：





若为自由缝，不显示当前缝纫段；

缝纫模式及段号针数选择：



1. 按下  键，数码管 T1T2 可在 00~05 之间循环显示当前缝纫模式；
 2. 按下  键，数码管 T3 可在 “E、F、G、H” 之间循环显示当前段号；
 3. 按下  或  键，对应的针数加 10 或加 1，0—99 之间循环；、 键无效；
- 按下  键，返回待机模式。

4.4 前固缝方式及针数设置

1. 在待机状态下、缝纫模式设定状态下或后固缝设定状态下:按  键, 均可进入前固缝方式设置状态, 此时 SBM 灯亮, 其余 LED 熄灭, T1 显示当前的前固缝方式;

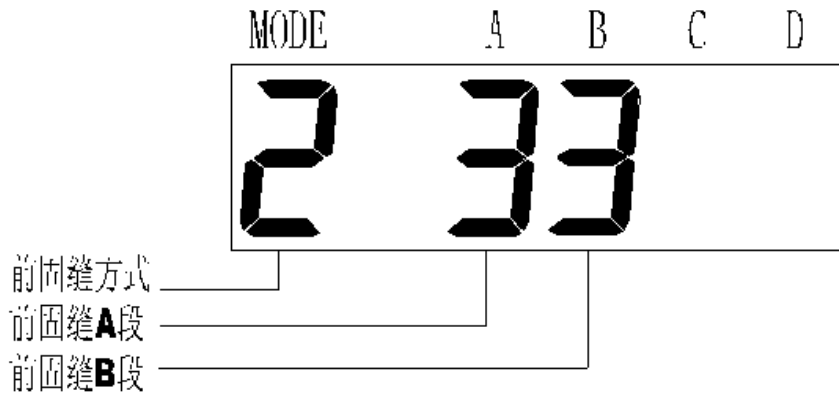
2. 按下  键, 数码管 T1 循环显示前固缝方式:0 (无前固缝)、1 (单前固缝)、2 (双前固缝)、3 (四前固缝), T3、T4 分别显示当前的固缝针数, 以前双固缝为例, 显示如下:



按  , 其上方对应的针数加一, 在 0~F 之间循环切换, 按  键返回待机状态。



4.5 后固缝方式及针数设置

1. 在待机状态下、缝纫模式设定状态下或后固缝设定状态下, 按  键, 均可以进入后固缝方式设置状态, 此时 EBM 亮, 其余 LED 熄灭, T2 显示当前的后固缝方式;

2. 按下  键, 数码管 T2 循环显示后固缝方式:0 (无后固缝)、1 (单后固缝)、2 (双后固缝)、3 (四后固缝),

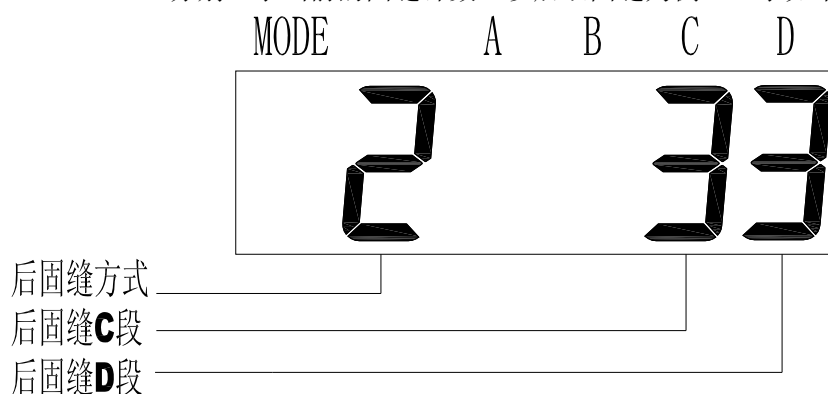
3. T5、T6 分别显示当前的固缝针数, 以后双固缝为例, 显示如下:。







按  , 其上方对应的针数加一, 在 0~F 之间循环切换, 按  键返回待机状态。

4.6 工艺参数设置

4.6.1 密码输入

1.在待机状态下连续按两次  键, P 灯点亮, 其它 LED 灯全熄, 此时便进入了工艺参数设置状态, 数码管显示密码输入:界面如下图所示:







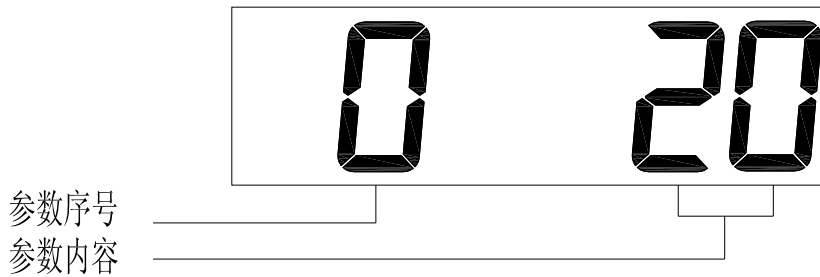

2.,按     键,可以输入密码, (出厂密码 2222 输入后, 按  确认。如果所输入的密码正确, 则进入工艺参数修改状态。显示如下:

4.6.2 工艺参数修改



1.在工艺参数设定状态下,  键为序号递增键,按该键可进行加 1 操作.,(序号值:0-99)

2 在状工艺参数设定态下,  键为序号递减键,按该键可进行减 1 操作.,(序号值:0-99)

3     各键在此状态下为参数设定键, 每按一键, 参数的对应位加 1 (如果加 1 后的参数值超出该参数的范围则不加); 每一个参数设置完后按  键, 保存该参数值, 再按一次  键返回待机模式。

4.7 常用参数说明表

(单位说明: RPM 转/分钟; ms 毫秒; s 秒; hour 小时;)

序号带*表示该参数修改后需要重新上电才能生效.

序号	功能参数	默认值	设定范围	单位	参数说明
P0	踏板斜率	20	1~100	%	斜率越大, 低速区域越大, 速度变化越大; 斜率越小, 低速区域越小, 速度变化越小。
P1	速度比例	8	1~8		自由缝最高速度的限定比例。将自由缝最高速度分成 8 等分, 通过调整等分值来改变当前自由缝最高速度
P2	系统最低转速	200	150~500	RPM	缝纫时, 机头最低转速限制
P3	自由缝最高转速	4000(平缝系列) 3000(双针系列) 5500(包缝系列)	150~5000 150~4000 150~7500	RPM	自由缝模式时, 机头最高转速
P4	定速缝速度	3500(平缝系列) 3000(双针系列)	200~4000	RPM	定长缝自动触发时的缝纫速度
P5	前固缝速度	1800	200~3000	RPM	执行前固缝时的缝纫速度
P6	后固缝速度	1800	200~3000	RPM	执行后固缝时的缝纫速度
P7	前固缝完暂停	off	0n/off		前固缝完毕暂停, 需要踏板触发后模式才继续运行
P8	后固缝前暂停	off	0n/off		后固缝前暂停, 需要踏板触发才执行后固缝
P9	W 缝速度	1800	200~3000	RPM	W 缝模式时的缝纫速度
P15	倒缝最高速度	2500	200~3000	RPM	倒缝时的最高速度
P16	扫线通电时间	50	20~1000	ms	扫线电磁铁的动作时间
P17	暂停过程中按键是否吸合倒缝电磁铁	on	0n/off		当电机不运转时, 按倒缝键是否允许倒缝电磁铁动作
P18	针迹/速度优先	0	0~1		缝纫时, 针迹或速度的优先级别设定 0: 针迹优先 1: 速度优先
P19*	抬压脚开关	0n	0n/off		开启或关闭抬压脚功能
P21	计数功能选择	0	0~2		0: 无计数功能 1: 底线计数功能 2: 剪线计数功能

P22	慢启动针数	2	0~15		以慢启动速度缝纫的针数
P23	慢启动速度	500	200~3000	RPM	慢启动缝纫时的速度
P24	底线基数	10	1~100		底线变化多少针时,当前计数变化 1 个单位。
P25	底线总数	2000	1~9999		设定的底线总数
P26	当前计数	2000	0~9999		当前的底线数量
P27	倒缝全额启动时间	200	20~500	ms	倒缝电磁铁的初始出力时间
P28	倒缝通电时间	2	1~50	ms	倒缝电磁铁力度保持时的高电平时间
P29	倒缝断电时间	2	1~50	ms	倒缝电磁铁力度保持时的低电平时间
P34 *	上电找针位	0n	0n/off		上电后,是否自动找到上针位点。
P36	剪线速度	250	200~500	RPM	剪线时的运转速度
P37 *	半后踏自动抬压脚	on	0n/off		开启或取消半后踏自动抬压脚
P39	第一针速度限定	3000	200-4000	RPM	第一针缝纫时的速度限定
P40	前固缝补偿参数 1	7 (平缝系列) 12 (双针系列)	0-16		前固缝针迹补偿参数 1
P41	前固缝补偿参数 2	5	0-16		前固缝针迹补偿参数 2
P42	后固缝补偿参数 1	7 (平缝系列) 12 (双针系列)	0-16		后固缝针迹补偿参数 1
P43	后固缝补偿参数 2	5	0-16		后固缝针迹补偿参数 2
P44	W 缝补偿参数 1	7 (平缝系列) 12 (双针系列)	0-16		W 缝针迹补偿参数 1
P45	W 缝补偿参数 2	5	0-16		W 缝针迹补偿参数 2
P46	手动老化开关	0	0/1		0: 正常操作模式 1: 老化拖车模式
P47	老化停顿时间	2000	100-9999	ms	老化时每次运行之间的时间间隔
P48	老化运行时间	2000	100 — 9999	ms	老化时每次运行的时间 (在没有定位器时有效)
P49 *	电机运转方向	1	0/1		0:CCW 1:CW
P51 *	剪刀模式	0	0/1		0: 内置剪刀 1: 外置剪刀。
P52	外剪刀工作时间	100	30~9999	ms	外剪线的动作时间
P53	外扫线工作时间	70	20~9999	ms	外扫线的动作时间
P54	安全开关信号型式	0	0/1		0: 常开 1: 常闭

P56	机头工作时间	0	0~9999	hour	机头已经工作了多长时间(每小时加1)
P57	抬压脚启动时间	250	20~1000	ms	抬压脚电磁铁的初始出力时间
P58	抬压脚通电时间	2	1~50	ms	抬压脚电磁铁的力保持时的高电平时间
P59	抬压脚关断时间	3	1~50	ms	抬压脚电磁铁的力保持时的低电平时间
P60	抬压脚保护时间	20	1~120	s	抬压脚工作保护时间
P61	抬压脚延迟时间	50	20~800	ms	电机停转后,多长时间开始抬压脚
P62	放压脚延迟时间	50	20~800	ms	压脚放下后,多少时间才允许启动
P64*	上电后自动抬压脚时间	0	0-900	s	上电后自动抬压脚的时间
P65	布边传感器功能选择	0	0-1		0: 无布边传感器 1: 有布边传感器
P66	布边传感器类型选择	2	0-3		0: N 输出低有效 1: N 输出高有效 2: P 输出低有效 3: P 输出高有效
P67	布边速度	800	200-5000	RPM	检测到布头信号后的运转速度
P68	全人工后踏剪线	311			311-剪线开启 非 311-剪线关掉
P69	布边延时启动时间	1000	100-9999	ms	检测到布头信号后的延时启动时间
P70	布头针数	10	1-100		布边传感器信号到针孔之间的距离
P71	布尾针数	10	1-100		布边传感器信号到针孔之间的距离
P73	有无布边传感器	off	0n/off		是否有外接布边传感器
P74	倒缝/抬压脚气动选择	0	0-3		0: 全部电动 1: 倒缝气动 2: 压脚气动 3: 全部气动
P76	剪线次数	0	0-9999		每剪一次线计数加1,加满清零
P77	针位信号输出控制	0	0-3		0: 上针位输出低电平有效 1: 下针位输出低电平有效 2: 上针位输出高电平有效 3: 下针位输出高电平有效
P98	参数恢复默认值	0000h	0-9999		
P99	工艺参数密码	2222h	0-9999		











5. 故障码/故障原因/故障排除方法表

故障显示代码	故障原因	故障排除方法
Err 1	系统故障	断电后检查机头是否卡住，然后重新上电，如果还不能解决，请联系售后服务人员
Err 2	系统过压	请检查电源电压是否正常？如果电源电压高于265V，关机，请等电源电压恢复正常再开机
Err 3	系统欠压	请检查电源电压是否正常？如果电源电压低于160V，关机，请等电源电压恢复正常再开机
Err 4	电机码盘故障	请检查电机连线是否正常。
Err 5	系统故障	重新上电，如果还不能解决，请联系售后服务人员
Err 6	系统故障	重新上电，如果还不能解决，请联系售后服务人员
Err 7	电机缺相	请检查电机电源线是否脱落或松动。
Err 8	电机堵转	1、电机电源线是否脱落 2、机头是否堵住 3、电机码盘线是否松动 4、上针位是否正确（有剪线动作的情况下）
Err 9	电机过载	1、布料是否太厚 2、机头是否堵住 3、上针位是否正确（有剪线动作的情况下）
Err 10	电机超速	1.电机码盘信号丢失； 2.光栅信号与电控版本不匹配
Err 11	电机码盘故障	请检查电机码盘线是否松动
Err 12	脚踏脱落故障	请检查脚踏连接线是否松动
Err 13	脚踏上电时被踩下	请检查脚踏是否被卡住
Err 14	电磁铁投入时间过长	1、上针位是否正确 2、布料是否太厚或线太粗导致剪线动作不正常
Err 15	制动回路故障	请检查刹车电阻连接线是否松动
Err 17	电磁铁过流故障	电磁铁故障，请检查电磁铁是否损坏或短路。
Err 18	制动回路故障	请检查刹车电阻连接线是否松动
Err 19-21	定位系统故障	电机可继续运转，但无针数记数、针位定位及剪/扫线及倒缝功能 请检查磁钢是否正常。 请检查机头是否被卡住。
Err 22	上位机通信故障	请检查控制面板与驱动器的连线是否正常
Err 23	存储器故障	重新上电，如果还不能解决，请联系售后服务人员
Err 24	机头润滑时间到	加上机器润滑油，然后恢复机头运转时间
Err 25	布边传感器故障	
Err 26	上电时检测到有布	1、将布拿开机器再重新来一次即可 2、布边传感器设定错误,重新设定布边传感器类型 3、布边传感器损坏



























如果在现场仍然消除不了，请联系供应商。

6. 七段数码管显示值与实际数值对照表

数字部分:

实际字符	0	1	2	3	4	5	6	7	8	9
显示字符										

英文字符:

实际字符	A	B	C	D	E	F	G	H	I	J
显示字符										
实际字符	K	L	M	N	O	P	Q	R	S	T
显示字符										
实际字符	U	V	W	X	Y	Z				
显示字符										

LIST

0. Main technical data.....	18
1. Safety notice	18
1.1 Range of use.....	19
1.2 Working conditions.....	19
1.3 Installation.....	19
1.4 Maintenance and inspection	20
1.5 Dangerous tips.....	20
1.6 Other safety requirements.....	20
2. Installation and adjustment.....	20
2.1 Installation of the control box	20
2.2 Adjustment of needle stop position	20
2.3 Adjustment of the reverse pressure for foot presser	21
3. Connection and grounding	21
3.1 Connection of power supply.....	21
3.2 Controller connection terminal map	22
3.2.1 General terminal connection diagram(lockstitch. interlock and overlock)	22
3.2.2 Special terminal connection diagram (overlock with the third sensor function)	23
3.2.3 Special terminal connection diagram (cylinder bed overlock)	24
4. Operating description of main control box panel	26
4.1 Layout of main control box panel as follows.....	25
4.2 Holding state	25
4.3 Sewing mode and each section stitches set	26
4.4 Fore-tacking sewing and stitches set	27
4.5 Back-tacking sewing and stitches set.....	28
4.6 Technical parameter set.....	28
4.7 Common parameter description.....	29
5. Table of error codes/cause/remedy.....	34
6. Table of the seven-segment LED display value and actual value comparison.....	35

0. Main technical data

Range of voltage: AC220V \pm 15%

Power frequency: 50Hz/60Hz

1. Safety notice

1.1 Range of use

The server-motor is designed for industry sewing machine, when using for other applications, please make sure that the users are safe.

1.2 Working conditions

1.2.1 Any fluctuations in the power voltage should be within the range of \pm 15% according to the control box marked.

1.2.2 In order to avoid error caused by disturbing control box, please keep away from high frequency electromagnetic emitter.

1.2.3 Humidity

a. The ambient temperature should be within the range of 5°C to 45°C during using.

b. Avoid exposure to direct sun or outdoors during using.

c. Keep away from the heating (heater) during using.

d. The relative humidity should be within the range of 30% to 95%.

1.2.4 Keep away from flammable gases or explosive during using.

1.3 Installation

1.3.1 Please install the controller correctly according to the introduction.

1.3.2 Please turn off and disconnect the power cord before installation.

1.3.3 Please keep away from rotating parts when installing the power cord, the distance should be at least 3cm.

1.3.4 In order to prevent noise interference or electric accident, make sure that the sewing machine and the control box are connected to ground. 

1.3.5 Make sure that the fluctuation in the power voltage should be within the range of \pm 15% according to the control box marked before turning on.

1.4 Maintenance and inspection

- 1.4.1 Please turn off before maintenance or inspection.
- 1.4.2 Make sure that the power switch is turned off when turning the machine head, replacing needle or rotary hook.
- 1.4.3 It is very dangerous because of high voltage inside the control box, if you want to uncover the control box, more than 5 minutes is needed to wait after power off.
- 1.4.4 Maintenance and inspection of the sewing machine should only be carried out by a qualified technician.
- 1.4.5 Forbidden to do maintenance and inspection when the motor is running.
- 1.4.6 All components for repair should be provided or approved before using.

1.5 Dangerous tips



This symbol indicates something you should be careful of when installing, failing to follow the instruction could cause injury when using the machine physical damage to equipment and surroundings.

1.6 Other safety requirements

- 1.6.1 Please operate the sewing machine at low-speed and check whether the direction of rotation is correct for the first time to power on.
- 1.6.2 Please don't touch the up wheel ,needle and other action parts when the sewing machine is running .
- 1.6.3 To prevent physical contact, all action parts must be isolated by protective devices, and please don't put anything into the devices.
- 1.6.4 Forbidden to operate at the circumstance of motor hood and other safety devices removed.
- 1.6.5 Don't let motor or control box fall to ground.
- 1.6.6 Don't let liquid ,such as tea, flow into the control box or motor.

2. Installation and adjustment

2.1 Installation of the control box

- 2.1.1 Install the control box and the foot-controller beneath the table.
- 2.1.2 Please connect the pedal with the control device
- 2.1.3 Installation diagram

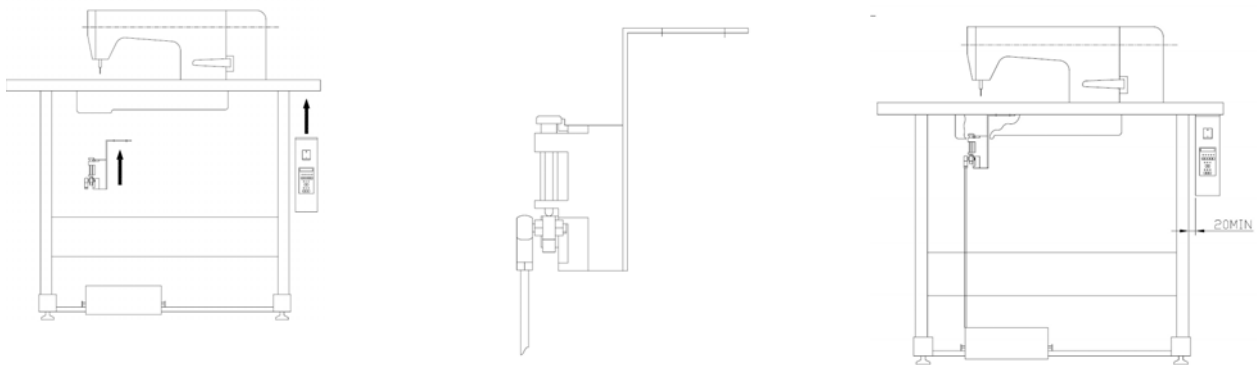

2.2 Adjustment of needle stop position

- 2.2.1 Release the magnet fixed screw of the hand wheel, re-fix after position adjustment.
- 2.2.2 If the actual needle stop position exceed the expected needle up position, adjust the magnet fixed plate on the indicative direction of the hand wheel rotation, conversely, adjust the hand wheel on the reverse direction of hand wheel rotation.

2.3 Adjustment of the reverse pressure for foot presser

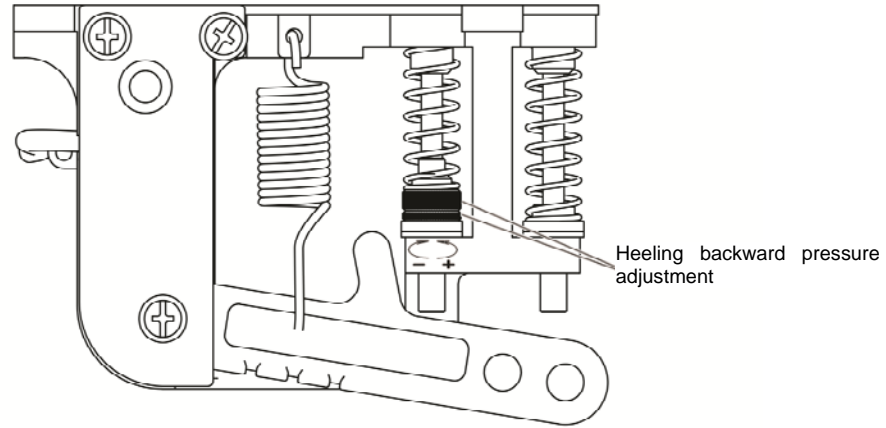

Adjustment requirements	Adjustment result
Adjustment of the reverse pressure for foot presser	Rotate the bolt at up, the reverse pressure will be heavy. Rotate the bolt at down, the reverse pressure will be light.

3. Connection and grounding

3.1 Connection of power supply

The controller is suitable for power supply of AC220V (one phase), the fluctuation of input voltage is within $\pm 15\%$ as the plate marked.



Notice:

The yellow /green power line are connected to ground, the connection to ground must be well done for insurance of safety and devices reliable to work.

3.2 Controller connection terminal map)

3.2.1 General terminal connection diagram(lockstitch. interlock and overlock)

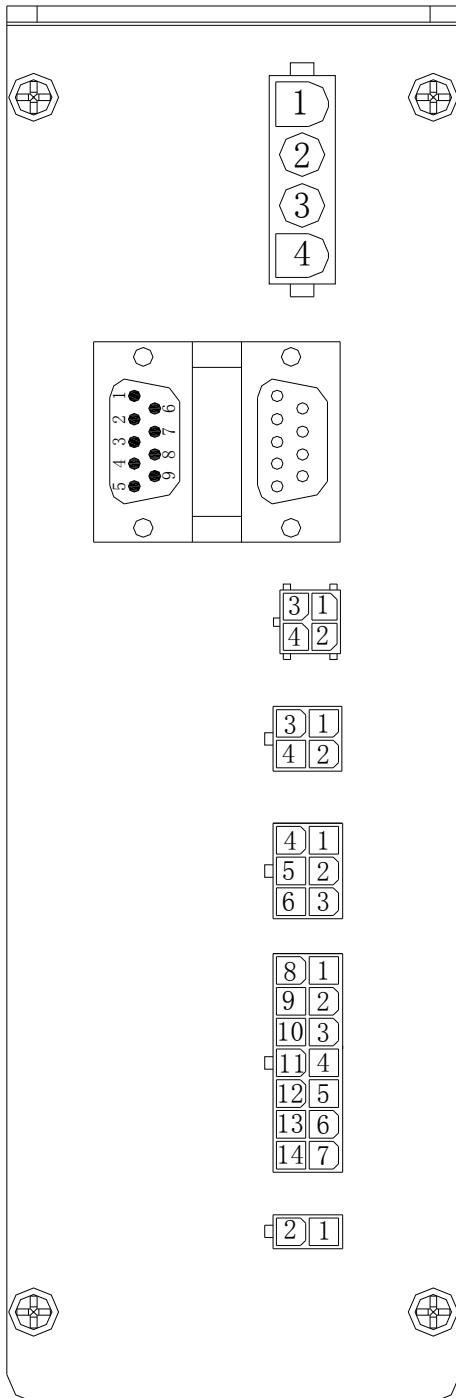

1. Ground
2. U phrase output
3. V phrase output
4. W phrase output

1. +5V
2. speed signal
3. stand foot pedal trimming control
4. stand foot pedal identify
5. GND
6. GND
7. GND
8. stand foot pedal foot presser control
9. +5V

1. TXD 2. +12V
2. RXD 4. GND

1. NC 2. safety switch
3. NC 4. +5v

1. needle position output 2. GND 3. GND
4. cloth edge sensor signal 5. GND
6. cloth edge sensor power

1. +30V 2.+30V 3.ground 4.+30V
5. GND 6. +30 PWM 7. GND 8.trimming output
9. thread sweep output 10. +30V 11.NC
12. manual reverse sewing switch
13. reverse sewing output
14. +5V lighting

1. +30V PWM
2. foot presser output

3.2.2 Special terminal connection diagram (overlock with the third sensor function)

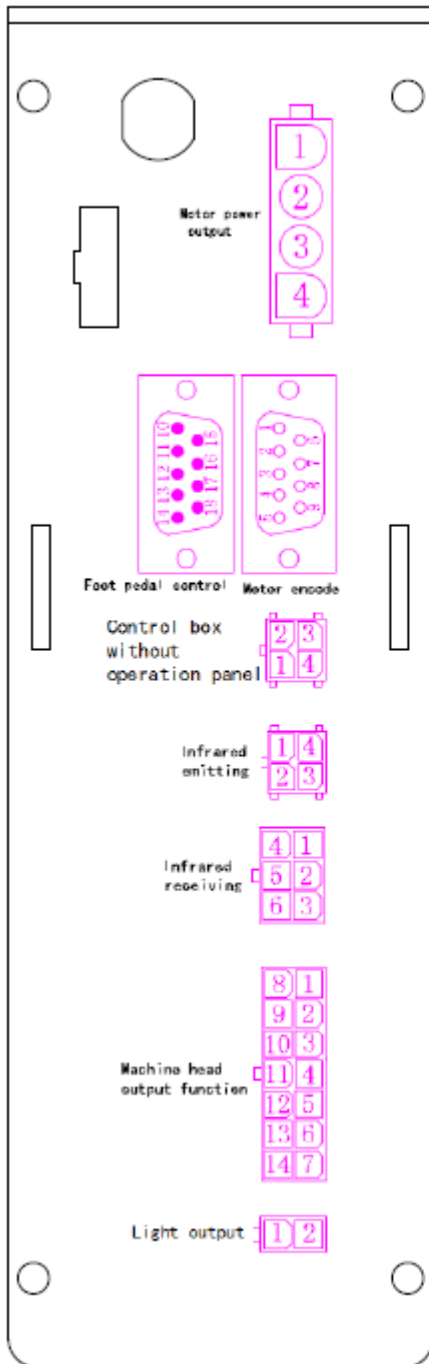

1	Ground			Motor power output	
2	U phrase output				
3	V phrase output				
4	W phrase output				
Foot pedal control			Motor encode		
10	+5V	15	GND	1	+5V
11	speed signal	16	GND	2	upper needle position
12	stand foot pedal trimming control	17	Stand foot pedal foot presser control	3	lower needle position
13	Stand foot pedal identify	18	+5V	4	Encoder B
14	GND			5	Encoder A
2	RXD	3	TXD	Control box without operation panel	
1	GND	4	+12V		
1	Before the infrared receiving	4	+5V	Infrared emitting	
2	Infrared emitting	3	After infrared emitting		
4	Before infrared receiving	1	+5V	Infrared receiving	
5	Infrared receiving	2	+5V		
6	After infrared receiving	3	+5V		
8	Thread trimmer solenoid	1	+30V	Machine head output function	
9	Presser foot solenoid	2	+30V		
10	Air suction	3	Reserved		
11	Fuller solenoid	4	Reserved		
12	Presser foot safety switch	5	GND		
13	Manual switch	6	GND		
14	Operation bed safety switch	7	+5V		
1	+12V	2	Lighting output	Light output	

3.2.3 Special terminal connection diagram (cylinder bed overlock)

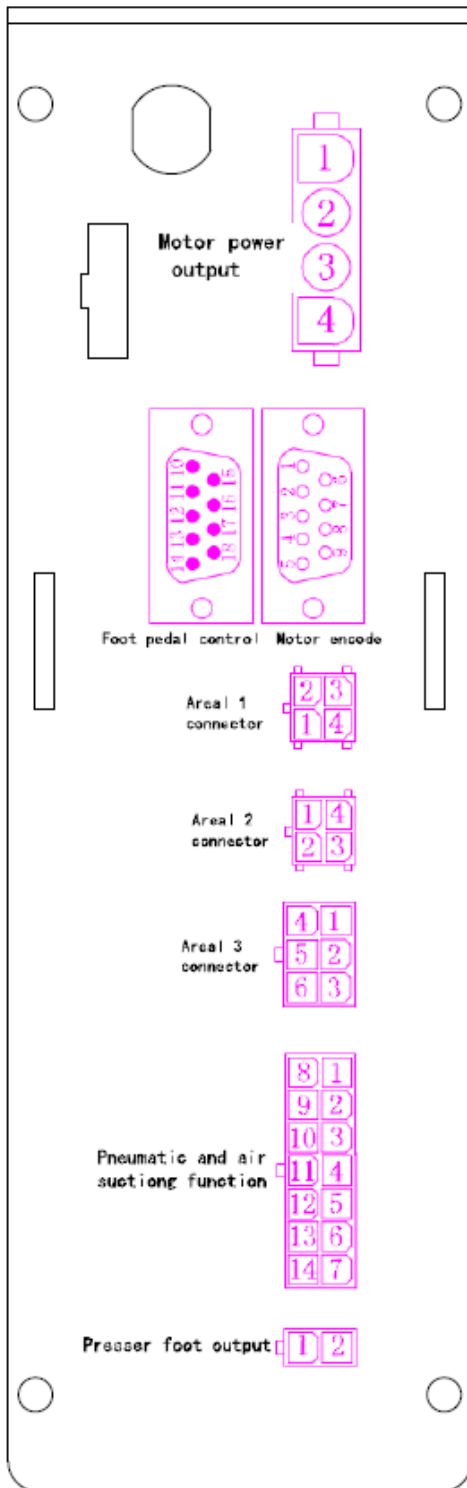

1	Ground			Motor power output			
2	U phrase output						
3	V phrase output						
4	W phrase output						
Foot pedal control				Motor encode			
10	+5V	15	GND	1	+5V	6	UH
11	speed signal	16	GND	2	upper needle position	7	VH
12	stand foot pedal trimming control	17	Stand foot pedal foot presser control	3	lower needle position	8	WH
13	Stand foot pedal identify	18	+5V	4	Encoder B	9	GND
14	GND			5	Encoder A		
2	Reserved	3	Reserved	Area 1 connector			
1	Reserved	4	Reserved				
1	Reserved	4	Reserved	Area 2 connector			
2	Reserved	3	Reserved				
4	Reserved	1	Reserved	Area 3 connector			
5	Reserved	2	Reserved				
6	Reserved	3	Reserved				
8	Reserved	1	Reserved	Pneumatic and air suctioning function			
9	Knee control switch	2	+30V				
10	Reserved	3	Reserved				
11	Reserved	4	Reserved				
12	Presser foot safety switch	5	GND				
13	Manual switch	6	GND				
14		7	+5V	Presser foot output			
1	+12V	2	presser foot output				

4. Operation description of the main control box panel

4.1 Layout of the main control box panel as follows

Layout of the main control box panel as follows, it includes six digital tube (T1-T6),eleven LED and ten buttons, the panel includes five states: holding mode, sewing mode set, fore-tacking mode set, back-tacking mode set, technical parameter set.

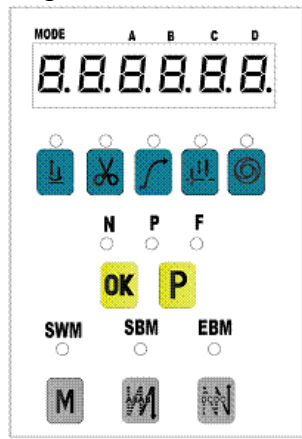

4.2 Holding state

1.The panel displays holding state when power on, N、P、F、SWM、SBM、EBM are turned off, the LED lamps at the top of function keys display according to the current parameter.

T1,T2 digital tube display current sewing mode(00:free sewing; 01:constant-dimension sewing; 02: four- segment sewing ; 03: seven -segment sewing; 04: eight-segment sewing; 05:W sewing),other digital tubes display “-”. Take current sewing mode free sewing for example, it displays as follows :

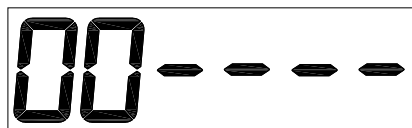

2.Choose  button, the corresponding functions of foot presser, thread trimmer ,slow start-up, needle stop position,automatic triggers and so on will be set or canceled, meanwhile the corresponding LEDs are on or off.

4.3 Sewing mode and each section stitches setting

Press  button at the holding state, then it goes into sewing mode set state: SWM is on, and other LEDs are off.

T1,T2 digital tube display current sewing mode(00:free sewing;01: constant-dimension sewing;02:four-segment sewing; 03:seven-segment sewing; 04:eight-segment sewing; 05:W sewing), if it is constant-dimension sewing or multi-segment sewing ,T3 digital tube display current section code “E、 F、 G、 H”,T5 and T6 digital tube display current section stitch.

Take four-segment sewing for example, it displays as follows:

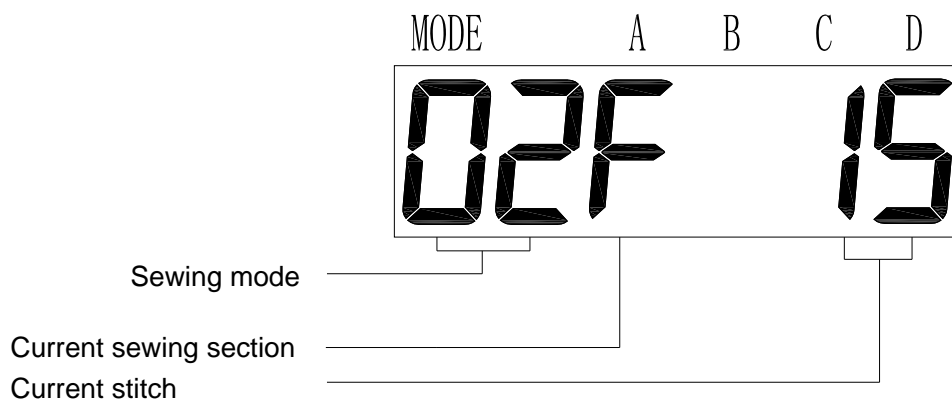





It doesn't display current sewing section if it is at free sewing .

Selection of sewing mode、 section number and stitches:

1. Press  button, T1,T2 digital tube can display circulatory current sewing mode among 00~05;

2. Press  button ,T3 digital tube can display circulatory current section number among “E、 F、 G、 H”.

3. Press  or  button, corresponding stitches added 10 or 1 and circularae among 0-99; 、  is invalid; press  button, it returns to the holding mode .

4.4 Fore-tacking sewing mode and stitches set





1. Press  button at the state of holding, sewing mode set or fore-tacking set, it all can go into the state of fore-tacking set, meanwhile SBM is on, other LED is off, T1 display current fore-tacking sewing mode.

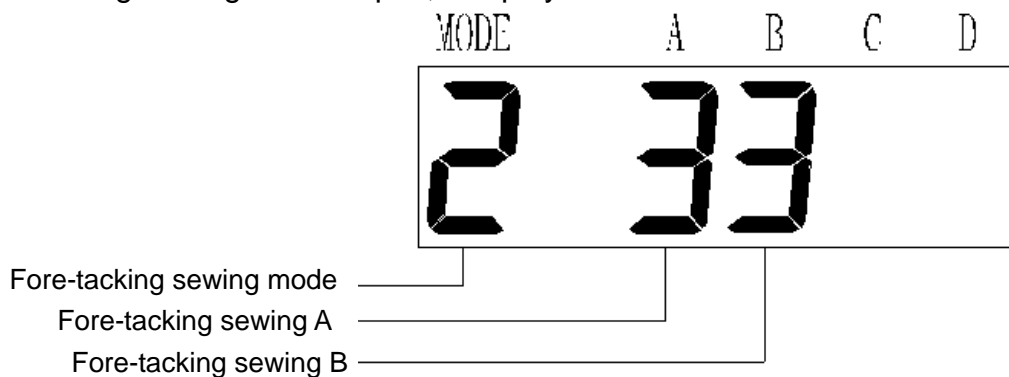

2. Press  button, T1 digital tube display circularly fore-tacking sewing mode : 0(no fore-tacking sewing),1(single fore-tacking sewing),2(double fore-tacking sewing) 3(four fore-tacking sewing),T3、T4 display current tacking stitches respectively, take double fore-tacking sewing for example ,it displays as follows:



Press   button, the corresponding stitches above added 1,switch circularly



among 0-F ,press  button, it returns to the holding state.

4.5 Back-tacking sewing and stitches set



1. Press  button at the state of holding, sewing mode set or back-tacking set,it all can go into back-tacking mode setting state, meanwhile EBM is on, other LED is off, T2 display current back-tacking mode .



2. Press  button, T2 digital tube display circularly back-tacking sewing mode: 0(no back-tacking sewing)、 1 (single back-tacking sewing)、 2 (double back-tacking sewing)、 3 (four back-tacking sewing) .

3. T5、T6 display current stitches of back-tacking sewing respectively ,take double back-tacking sewing for example ,it displays as follows:

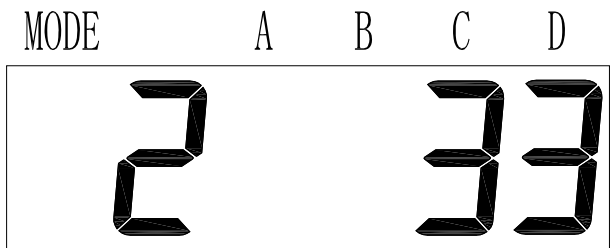

Back-tacking sewing mode
 Back-tacking sewing C
 Back-tacking sewing D

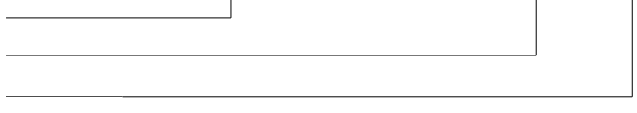

Press button, the corresponding stitches above added 1, switch circularly



among 0-F, press button, it returns to the holding state.

4.6 Technical parameter set

4.6.1 Password input

1. Press **P** twice continually at the holding state, P light is on ,other LED is off, it goes into the state of technical parameter setting, digital tube display password input as follows :

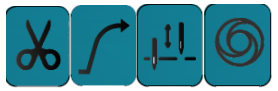

2. Press button,it can input password, the initial input password is



2222,press to confirm, if the entered password is correct ,then it goes into the state of modifying technical parameter ,display as follows :

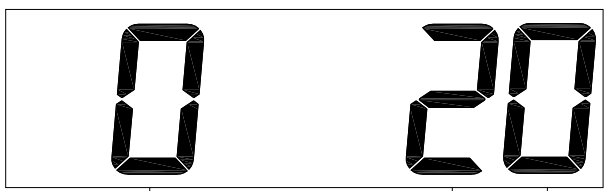





Parameter number
 Parameter contents





4.6.2 Modify the technical parameter

1. At the technical parameter setting state,  is sequence increasing key, press this key can do operation of added 1 (sequence: 0-99)

2. At the technical parameter setting state,  is sequence descending key, press this key can do operation of minus 1 (sequence :0-99).

3.     are parameter setting key at this state, press the key once, parameter of corresponding bit adds 1 (it will not continue if the parameter overflow after adding);

press  key to save the parameter after setting, press  key again to return to the holding state .

4.7 Common parameter description

The parameters marked with *mean that they should re-power after amended.

(Unit: RPM; ms ; s ; hour)

Sequence	Function parameter	Default	Setting range	unit	Parameter description
P0	Pedal slope	20	1~100	%	The bigger the slope is, the larger the low-speed region is, and the faster the speed change is; the smaller the slope is, the narrower the low-speed region is, and the lower the speed change is.
P1	Speed proportion	8	1~8		Presser proportion of the maximum speed of reverse sewing. The maximum speed is equally divided into eight parts, current speed can be modified through adjusting parts.
P2	System minimum speed	200	150~500	RPM	The minimum speed of machine head when sewing.
P3	Maximum speed of the reverse sewing	4000(lockstitch series) 3000(double needle series) 5500(overlock stitch series)	150~5000 150~4000 150~7500	RPM	The maximum speed of machine head at the reverse sewing.
P4	Fixed sewing speed	3500(lockstitch series) 3000(double needle series)	200~4000	RPM	Sewing speed of fixed sewing speed.
P5	Fore-tacking sewing speed	1800	200~3000	RPM	Sewing speed of fore-tacking.
P6	Back-tacking sewing speed	1800	200~3000	RPM	Sewing speed of back-tacking.

P7	Suspend when the fore-tacking finished.	off	On/off		Pedal trigger is needed to continue operating when suspend at fore-tacking finishing.
P8	Suspend when the back-tacking finished.	off	On/off		Pedal trigger is needed to continue operating when suspend at back-tacking finishing.
P9	W sewing speed	1800	200~3000	RPM	Sewing speed at W sewing mode.
P15	Maximum speed of reverse sewing.	2500	200~3000	RPM	Maximum speed of reverse sewing.
P16	Working time of thread sweep	50	20~1000	ms	Working time of thread sweep electromagnet.
P17	Whether the reverse sewing key will be absorbed when the motor stops.	On	On/off		When the motor stops, and the key pressed, whether the electromagnet act or not.
P18	Stitch/speed priority	0	0~1		Stitch or speed priority setting during sewing: 0:stitch priority 1:speed priority
P19*	Foot presser switch	On	On/off		Turn on/off the function of foot presser.
P21	Selection of counting function	0	0~2		0:Non-counting function 1:Bobbin thread counting function 2:Trimming thread counting function
P22	Slow-startup counting	2	0~15		Stitches when sewing at slow-startup speed
P23	Slow-startup speed	500	200~3000	RPM	The sewing speed at slow-startup.
P24	Bobbin-thread base number	10	1~100		How many stitches changes on bobbin-thread, the current count change one unit.
P25	Total number of bobbin-thread	2000	1~9999		Total number of bobbin-thread setting.
P26	current counting	2000	0~9999		Current amount of bobbin-thread.
P27	Full PWM on time of reverse sewing	200	20~500	ms	Initial startup time of reverse sewing electromagnet.
P28	PWM on time of reverse sewing	2	1~50	ms	PWM on time of reverse sewing when the electromagnet holding on.

P29	PWM off time of reverse sewing	2	1~50	ms	PWM off time of reverse sewing when the electromagnet holding on.
P34*	Automatic finding needle position	On	On/off		Whether automatic finding the needle up position at PWM on time.
P36	Trimming speed	250	200~500	RPM	Operating speed when trimming.
P37*	Automatic lift foot presser of half back step	on	On/off		Start or cancel automatic lift foot presser of half back step.
P39	Speed limitation of the first stitch	3000	200-4000	RPM	The limitation for the speed of the first sewing stitch.
P40	Fore-tacking sewing compensation parameter 1	7 (lockstitch series) 12 (two-needle lockstitch series)	0-16		Fore-tacking stitch sewing compensation parameter 1.
P41	Fore-tacking sewing compensation parameter 2	5	0-16		Fore-tacking sewing stitch compensation parameter 2.
P42	Back-tacking sewing compensation parameter 1	7 (lockstitch series) 12 (two-needle lockstitch series)	0-16		Back-tacking sewing stitch compensation parameter 1.
P43	Back-tacking sewing compensation parameter 2	5	0-16		Back-tacking sewing stitch compensation parameter 2.
P44	W sewing compensation parameter 1	7 (lockstitch series) 12 (two needle lockstitch series)	0-16		W sewing stitch compensation parameter 1.
P45	W sewing compensation parameter 2	5	0-16		W sewing stitch compensation parameter 2.
P46	Manual test mode switch	0	0/1		0: normal operation mode 1: test mode
P47	Manual test mode switch	2000	100-9999	ms	The interval time between each operation at test mode
P48	Operating time of test mode	2000	100—9999	ms	Each operating time of the test mode.

P49*	Motor operation direction	1	0/1		0:CCW 1:CW
P51*	Scissors mode	0	0/1		0: built-in scissors 1: built-out scissors
P52	Working time of built-out scissors	100	30~9999	ms	Working time of built-out scissors.
P53	Working time of external thread sweep	70	20~9999	ms	Working time of external thread sweep.
P54	Type of safety switch signal	0	0/1		0: open 1:shut
P56	Working time of machine head	0	0~9999	hour	How many hours the machine head have worked.(add 1 per hour)
P57	Startup time of lifting foot presser	250	20~1000	ms	Initial startup time of lifting foot presser electromagnet.
P58	PWM on time of lifting foot presser	2	1~50	ms	PWM on time of lifting foot presser when the electromagnet holding on.
P59	PWM off time of lifting foot presser	3	1~50	ms	PWM off time of lifting foot presser when the electromagnet holding on.
P60	Protection time of foot presser lifting	20	1~120	s	Protecting time of foot presser lifting during working.
P61	Delay time of lifting foot presser	50	20~800	ms	How long will it be to start to lift foot presser after the motor stop.
P62	Delay time of downing foot presser	50	20~800	ms	How long is it allowed to startup after foot presser is down.
P64*	Automatic foot presser lifting time with power on	0	0-900	s	Time of automatic lifting foot presser with power on.
P65	Function selection of cloth edge sensor	0	0—1		0: no cloth edge sensor 1: cloth edge sensor
P66	Selection of cloth edge sensor type	2	0—3		0: N output is effective at low 1: N output is effective at high 2: P output is effective at low 3: P output is effective at high
P67	Speed of cloth edge	800	200-5000	RPM	Operating speed when detecting cloth edge signal.
P68	Thread trimming(back step) Manual type	311			311 thread trimmer turned on Non 311, thread trimmer turns off

P69	Delay-startup time of cloth margin	1000	100-9999	ms	Delay-startup time when detecting cloth head signal.
P70	Stitch of cloth head	10	1-100		The distance between Cloth edge sensor signal and needle hole.
P71	Stitches of fabric edge	10	1-100		Distance of the fabric edge sensor signal to the needle plate hole
P73	Cloth edge sensor	off	On/off		Whether there is an external cloth edge sensor.
P74	Selection of back stitch/ foot presser lifting air-operated	0	0-3		0: all electric-operated 1: reversing air-operated 2: presser foot air-operated 3: all air-operated
P76	Number of trimming	0	0-9999		Adding 1 to the counter per trimming, clear to zero when the counter is full.
P77	Control of needle position signal output	0	0-3		0: The output of needle up position is effective at low 1: The output of needle down position is effective at low 2: The output of needle up position is effective at high 3: The output of needle down position is effective at high
P98	Parameter recover to default	0000h	0-9999		
P99	Technical parameter password	2222h	0-9999		

5. Table of error codes/cause/remedy

Error code	Cause	Remedy
Err 1	System error	Check whether the machine head is stuck, and then re-power, if the malfunction have not been solved yet, please contact after-sale service.
Err 2	Overload voltage	Please check whether the power supply voltage is normal, if the power supply voltage is higher than 265V, turn off the machine, and restart the machine until the power supply voltage is normal .
Err 3	Download voltage	Please whether check the power supply voltage is normal, if the power supply voltage is lower than 160V, turn off the machine, and restart the machine until the power supply voltage is normal.
Err 4	Motor code wheel error	Please check whether the motor electrical connection is normal.
Err 5	System error	Re-power , if the malfunction have not been solved yet ,please contact the after-sale service person.
Err 6	System error	Re-power , if the malfunction have not been solved yet ,please contact the after-sale service person.
Err 7	Motor lack phase	Please check whether the motor power cord is off or loose.
Err 8	Motor locked-rotor	1. Check whether the motor power cord is off. 2. Check whether the machine head is stuck. 3. Check whether motor code wheel cord is loose. 4.Check whether the needle up position is correct (at the case of thread trimming movement).
Err 9	Motor overload	1. Check whether the fabric is too heavy. 2. Check whether the machine head is stuck. 3. Check whether the needle up position is correct (at the case of thread trimming movement).
Err 10	Motor over speed	1.Motor encode signal lost 2. Grating signal doesnt match the control box version
Err 11	Motor code wheel error	Please check whether the motor code wheel cord is loose.
Err 12	Foot-controller dropped off error	Please check whether the foot-controller connection is loose.
Err 13	Foot-controller was off when turning on the electricity	Please check whether the foot-controller is stuck.
Err 14	The time of using Electromagnet is too long	1. Check whether the needle up position is correct. 2. Check whether the fabric is too heavy or the line is too thick to cut the line normally.
Err 15	Brake circuit error	Please check whether the brake resistor cable is loose.
Err 17	Electromagnet overload current error	Electromagnet error, please check whether the electromagnet is broken or short circuit.
Err 18	Brake circuit error	Please check whether the brake resistor cable is loose.

Err 19–21	Located system error	Motor can continue to operate, but there are no needle count, needle location ,trimming/sweep and reverse stitch function. Please check whether the alnico is normal. Please check whether the machine head is stuck.
Err 22	Machine up position communication error	Please check whether the connection of the control panel and the drive is normal.
Err 23	Memory error	Re-power, if the error has not been solved yet ,please contact the after-sale service person.
Err 24	Machine head lubrication time is up	Add the lubrication oil , and then recover the operate time of machine head.
Err 25	Fabric edge sensor error	
Err 26	Detected cloth when turning on the electricity	1. Take the cloth away and retry. 2.The cloth edge sensor setting is wrong, reset the type of cloth edge sensor. 3.The cloth edge sensor is broken.

If the error still can not be resolve, please contact the supplier .

6. Table of the Seven-Segment LED display value and actual value comparison

Figure part:

Actual character	0	1	2	3	4	5	6	7	8	9
Display character										

English character:

Actual character	A	B	C	D	E	F	G	H	I	J
Display character										
Actual character	K	L	M	N	O	P	Q	R	S	T
Display character										
Actual character	U	V	W	X	Y	Z				
Display character										